

MVC640-C4-F13

For the operation video, please refer to [MVC640-C4-F13 Unboxing](#).

Minimum Requirements

- A display connected to MCore Pro (not included).
- A Microsoft Teams Rooms or Skype® for Business account (not included).
- Wired network environment (not included).

Package Contents

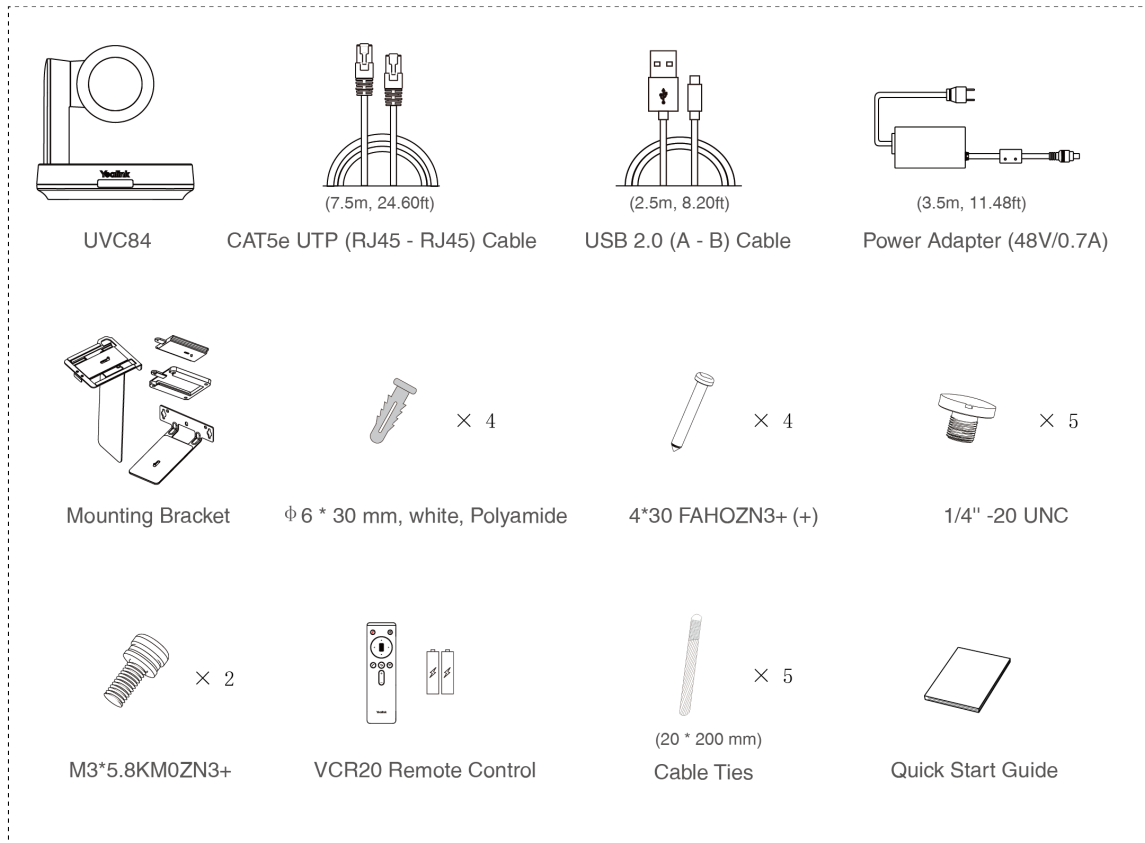

UVC84 Package

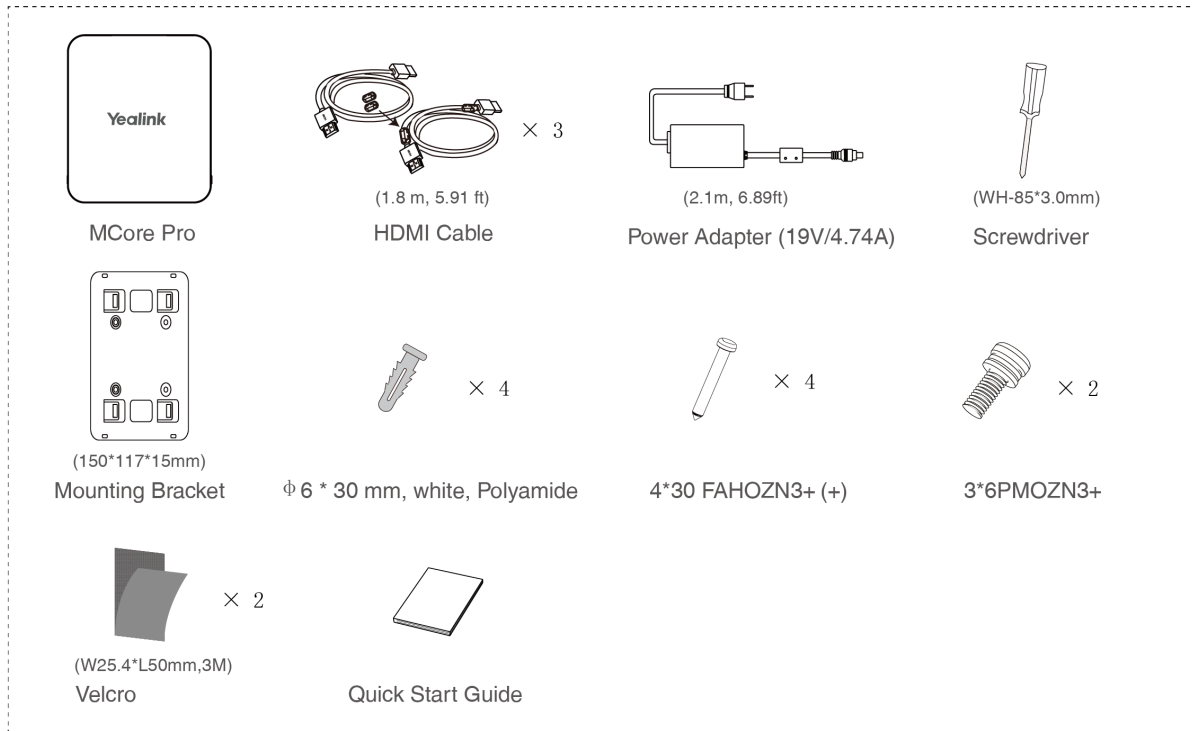

MCore Pro Package

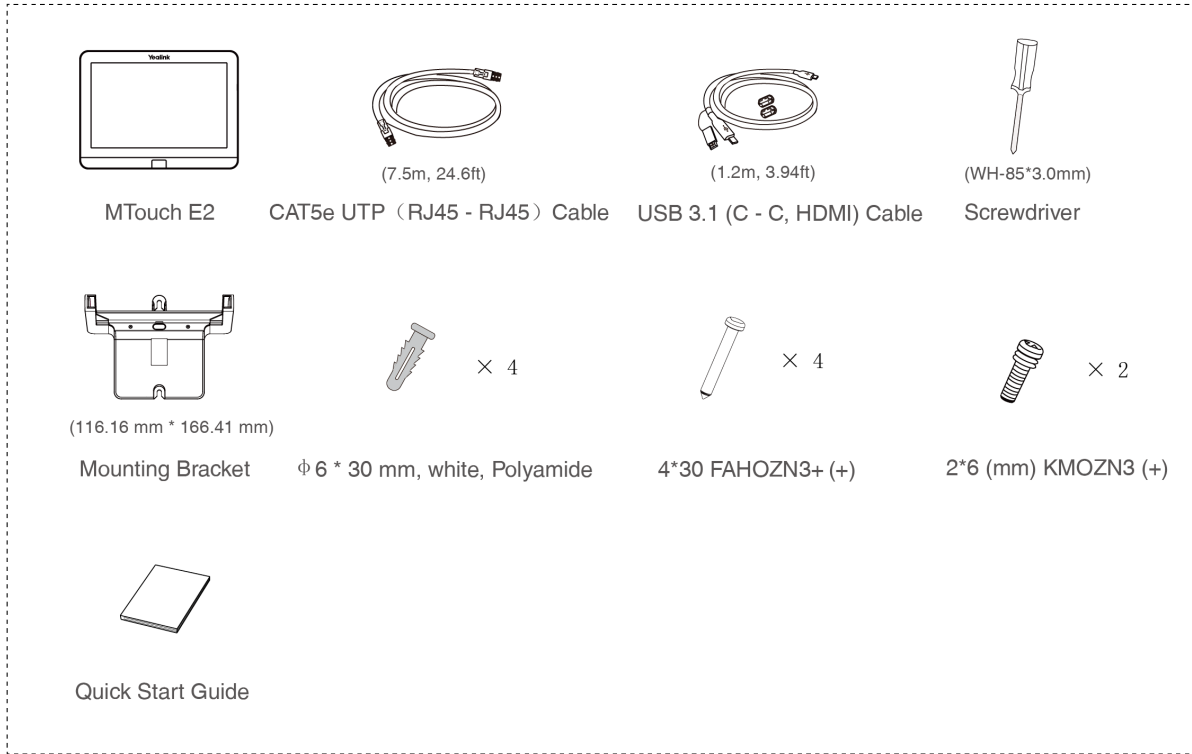

MTouch E2 Package

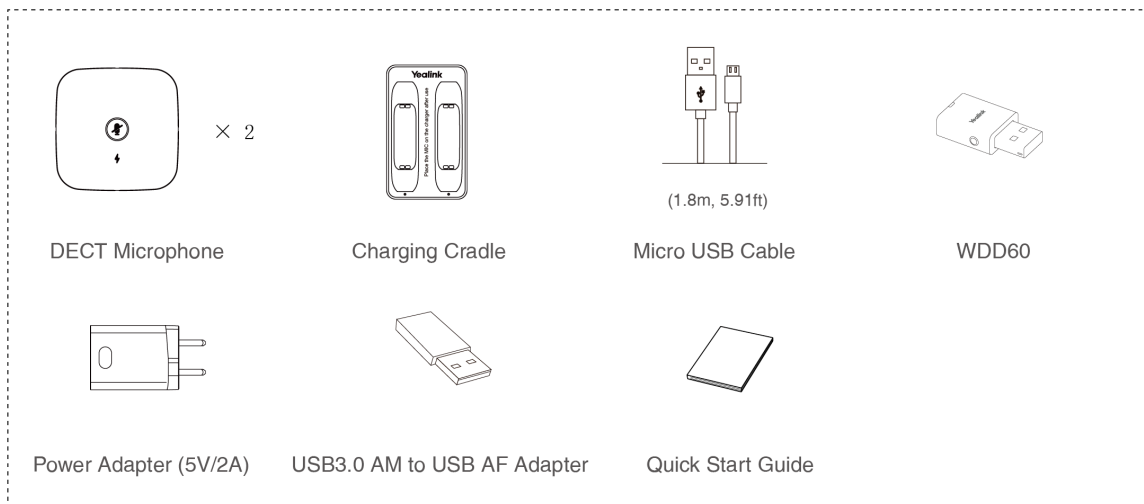

CPW65 Package

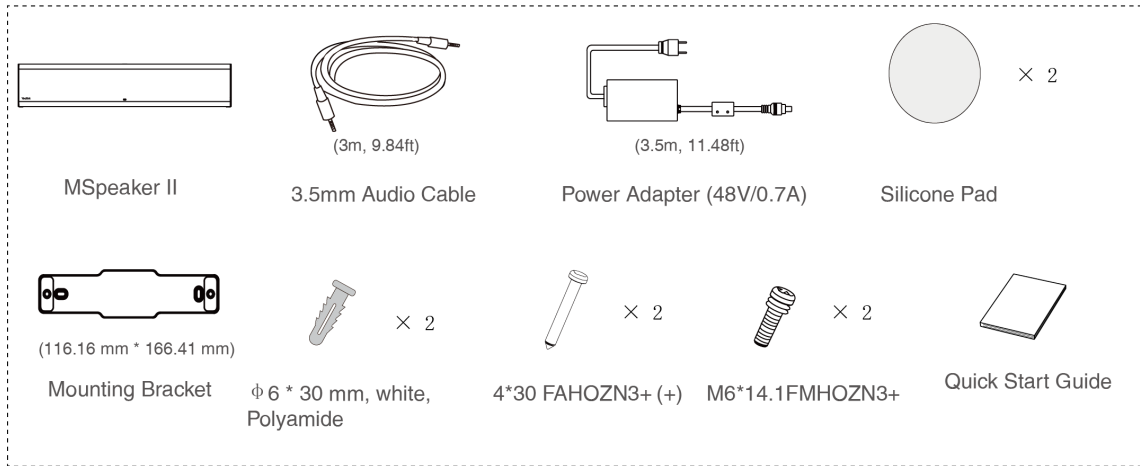

MSpeaker II Package

Install MVC640-C4-F13

- MCore Pro supports: mount on the wall, mount on the TV, stick to the table.
- MTouch E2 supports: put on a table, mount on a wall.
- UVC84 supports: put on a flat surface, mount on top of a display, mount on the wall, mount on the ceiling, mount on the TV mount.
- Install and deploy the accessories in the system according to the environment and actual needs. For how to install and deploy, please refer to the quick start guide of each product.

Connect MVC640-C4-F13

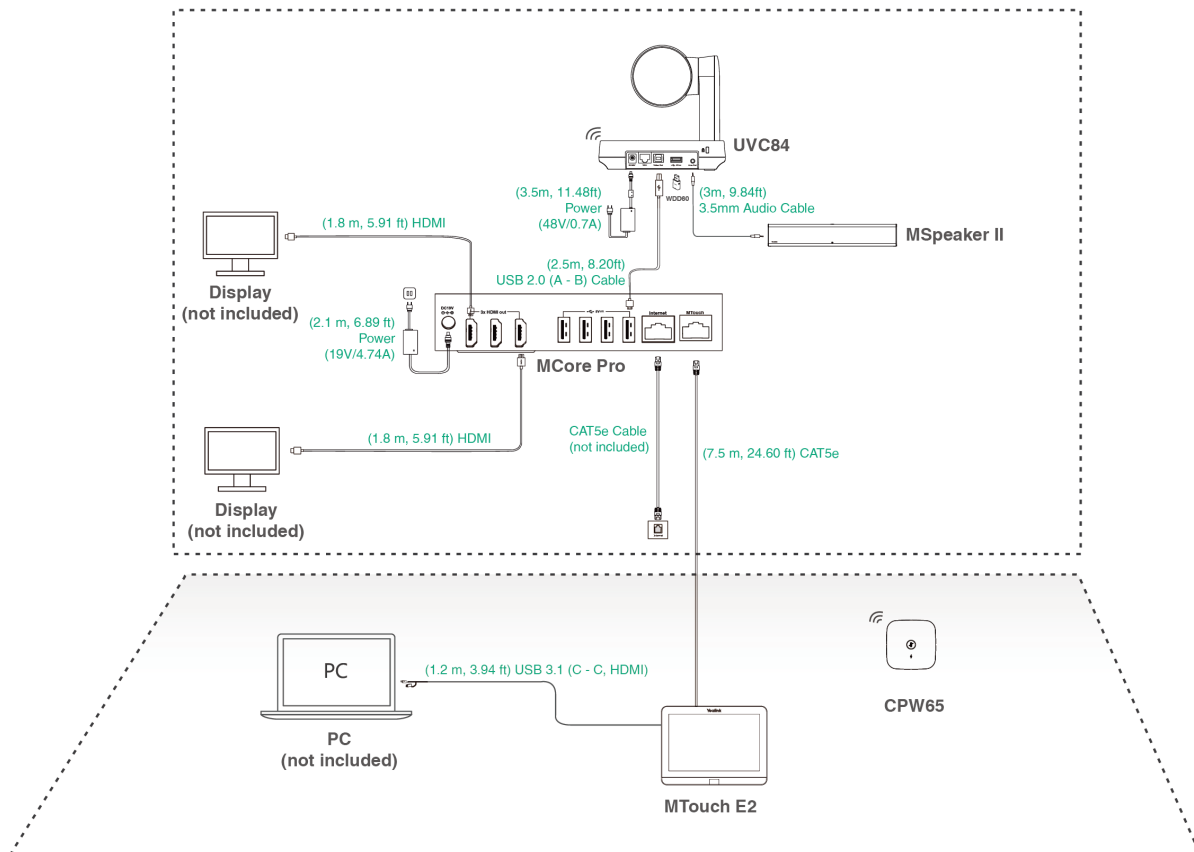

NOTE

- When starting up the system for the first time, you need to connect a mouse to complete the initial configuration. We recommend using the wireless mouse and keyboard kit.
- The maximum cable connection distance from MCore Pro to the MTouch Plus/E2 is 40m/131ft and can not be extended further.
- Not included accessories requirements:
 - Display: Resolution of 1080p or higher and with an HDMI port.
 - PC: Equipped with HDMI or USB-C (support DP protocol) Port.
 - Ethernet cable: CAT5e or higher ethernet cable.
 - HDMI: Standard HDMI cable.
 - PoE switch: If you use PoE to connect speakers or cameras, you need to use PoE+.
- USB-C Cable with DisplayPort standard is recommended for MTouch Plus/E2 content share cables, original content share cable in MVC kits can also be purchased separately.

Initial Setup

1. Press the power button on the bottom left of MCore Pro, and the Microsoft Windows 10 IoT Enterprise Edition operating system will be automatically loaded after starting MCore Pro.

NOTE

When starting up the system for the first time, you need to connect a mouse to complete the initial configuration. We recommend using the wireless mouse and keyboard kit. After the system is initialized, you can use MTouch E2 to complete the system login and settings, and the device will automatically start the Microsoft Teams conference system application and enter the setting page.

2. Select the check box on the **EULA** page, and then tap **Next**.
3. Enter the account, the password on the **Account** page, and then tap **Next**. Supports Microsoft Teams Rooms or Skype® for Business accounts.
4. On the **Advanced** page, configure the domain and tap **Next**.
5. Tap **Finish** to complete the setup wizard.

Features

Control UVC84 Camera Position

1. Tap More >  to enter the Camera Control page.

Supported Accessories

For the compatible devices and the maximum number of compatible devices, please refer to [Teams Room Accessories Compatibility Lists](#).